

MASTER CONTROLLER

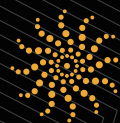

SONOFARM

Ultra X-Wifi LED GROW LIGHT USER MANUAL

IMPORTANT PRODUCT INFORMATION

- Please read this manual thoroughly before attempting to install or operate our LED products.
- After successful installation and configuration of the system, be sure to keep this manual in a safe place for future reference. Safety is a key component to a long lasting and trouble-free installation.
- Use all of our products only as guided, failure to observe the following safety warnings may result in serious injury or death, and a waiver of any and all liability for its manufacturer, and re-sellers by law.

WARNINGS AND INSTRUCTIONS FOR USE:

⚠ Warning: To reduce the risk of electrical shock possibility of serious injury, always take the proper precautions and unplug the fixture before moving or cleaning.

⚠ Warning: In the event that the light bar becomes submersed, first to disengage the circuit breaker, then unplug the fixture before proceeding to remove from water.

⚠ Warning: Our LED grow lights are for indoor use only. Do not expose to water drip or spray. Do not expose the lights to physical harm such as impact or severe environmental conditions. Working temperature is 68°F-86°F / 20°C -30°C.

⚠ Warning: When installing our LED grow lights, ensure that the power outlets are properly grounded and have adequate capacity. If there is any doubt, please consult an electrician. Please ensure that there is adequate space for airflow around the lights. A minimum of 12 inches of space are recommended above the light and 2 inches at the sides.

⚠ Warning: To prevent eyes damage, avoid looking directly at the lights when they are lighting on. Use shielding and light blocking glasses to protect your eyes.

⚠ Warning: Never place the fixture "face down" on a surface, as it may damage the diodes.

⚠ Caution LED and heat sink surfaces may be hot. Allow sufficient cooling time before handling.

⚠ Caution To reduce the risk of overheating, never place operating fixtures face down on a flat surface. Always allow for adequate ventilation of fixtures and power supplies.

Recommendation: It is highly recommended that surge suppressors are installed to protect your grow light investment. Power surges are one of the leading causes of premature grow light failure.

OVERVIEW

Thank you! You've just purchased the best, most complete spectrum LED grow light the industry has ever seen.

Our LEDs are high performance grow lights capable of outperforming HID technology by nearly 50%.

Our lights set a new level for LED grow lighting. They are powerful enough to be used as the primary source of light in all indoor growing applications.

We strive to help you maximize your yields by offering the best lights that emit a full spectrum, sufficient light intensity (PPFD), and cover your entire grow space with that intense light.

Thank you for purchasing our products again. We are sure you will be happy with the results you achieve.

CONTENTS

1. Package Contents
2. Installation Instructions (Wireless Control)
3. Installation Instructions (Wired Control)
4. Product Dimensions
5. Warranty Service

PACKAGE CONTENTS

The package contains:

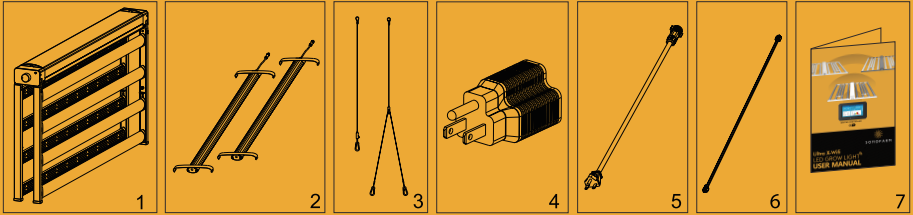

- | | |
|------------------|---------------|
| 1 LED Grow Light | 5 Power Cord |
| 2 UV/IR Bars | 6 RJ Cord |
| 3 Steel Cable | 7 User Manual |
| 4 Plug Adapter | |

INSTALLATION INSTRUCTIONS **Wireless Control**

Take caution when handling light bars. Ensure the LED diodes do not come in contact with sharp objects that may damage them.

- 1 Unbox the light and place it on a flat surface. Make sure the surface is clear of objects which may damage LEDs.
- 2 Ensure the fixture is not plugged into the electrical power.
- 3 a. Press and hold to remove (or lock or adjust)the steel cables.
b. Loop the steel cables around a secure structure and back to the adjuster.
c. Attach the carabiners of the hanging steel cables to the two hanging anchors.

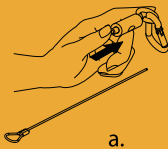
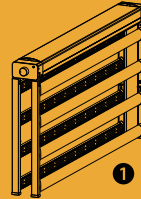

a.

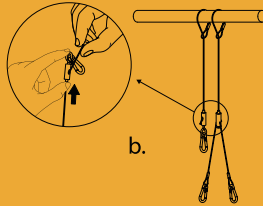

b.

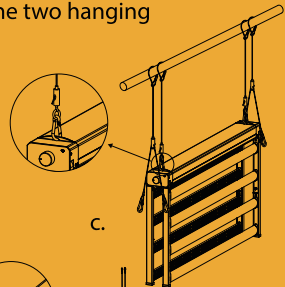

c.

- 4 Unfold the fixture and attach the carabiners of the longer steel cable to hooks on each side, adjust the cable by pressing the locker.

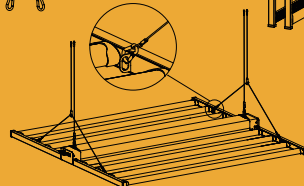

- 5 Mount UV/IR bars and connect the power cords on the side bars.



- 6 Connect the power cord with the light and then plug into a properly grounded power receptacle.

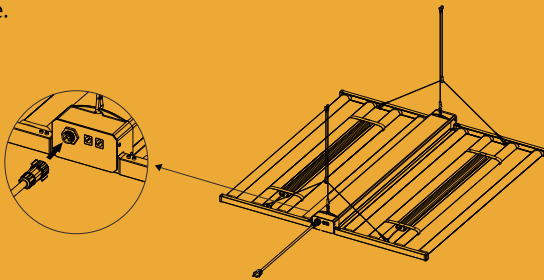

- 7 Switch rotary knob on all fixtures to "EXT". Power connect with the controller.



- 8 All done.

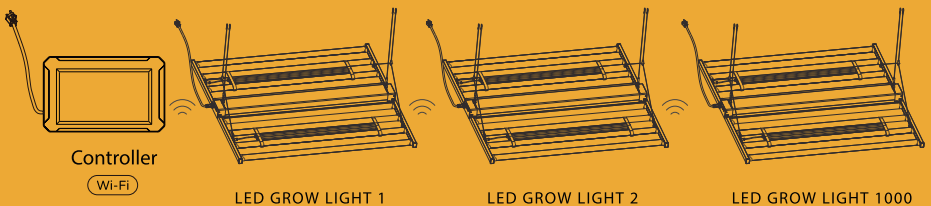

INSTALLATION INSTRUCTIONS **Wired Control**

Take caution when handling light bars. Ensure the LED diodes do not come in contact with sharp objects that may damage them.

- 1 Unbox the light and place it on a flat surface. Make sure the surface is clear of objects which may damage LEDs.

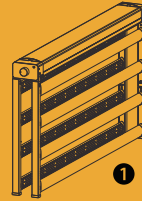

- 2 Ensure the fixture is not plugged into the electrical power.

- 3 a. Press and hold to remove (or lock or adjust)the steel cables.
b. Loop the steel cables around a secure structure and back to the adjuster.
c. Attach the carabiners of the hanging steel cables to the two hanging anchors.

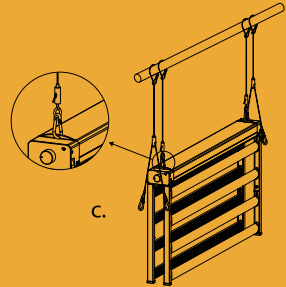
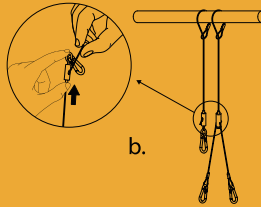
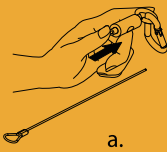

- 4 Unfold the fixture and attach the carabiners of the longer steel cable to hooks on each side, adjust the cable by pressing the locker.

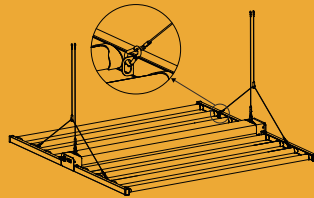

- 5 Mount UV/IR bars and connect the power cords on the side bars.

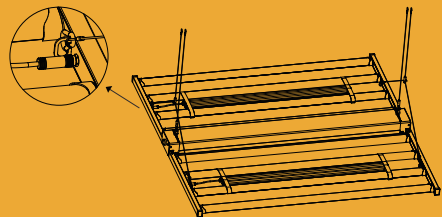
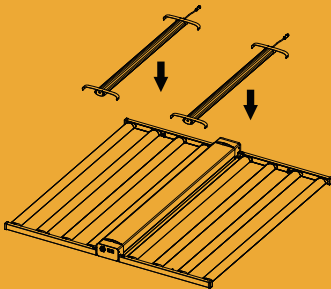

- 6 Connect one end of the RJ cord to the RJ port of controller, and the other end to the DIM IN of LED GROW LIGHT. (repeat the same action until you wire all the fixtures you have)

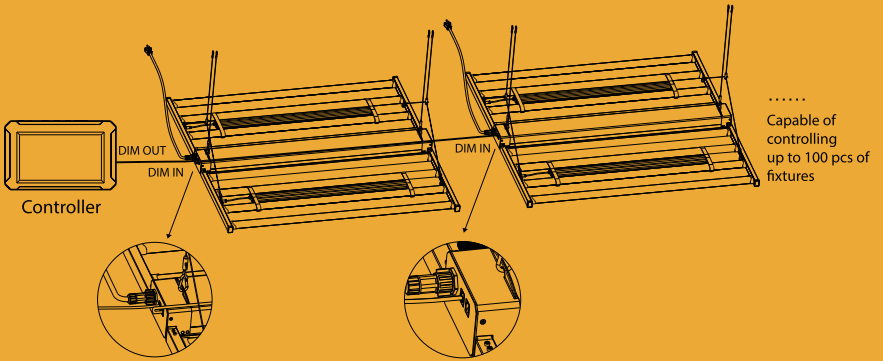

- 7 Switch rotary knob on all fixtures to "EXT". Power connect with the fixtures.

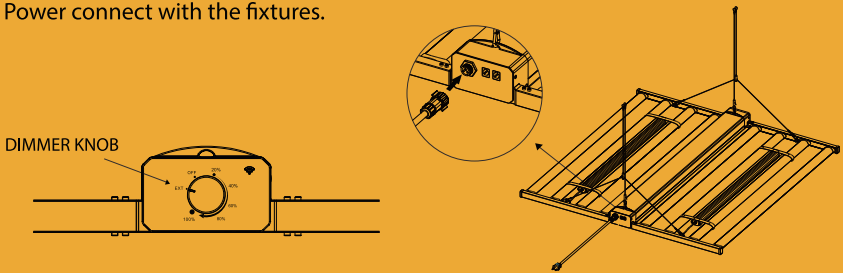

- 8 Connect the controller with the first or the last fixture by RJ cable. Power connect with the controller. All done.

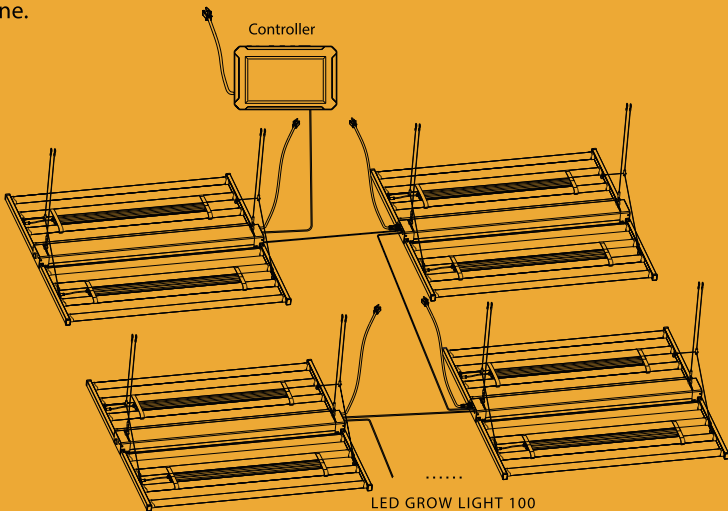

PRODUCT DIMENSIONS

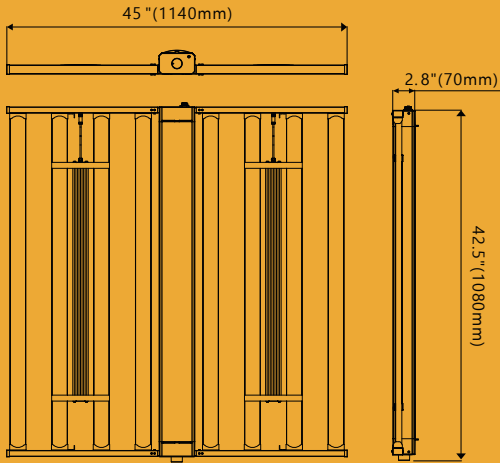

WARRANTY SERVICE

If the product will not work after you have read the troubleshooting guide and practiced the troubleshooting options, you are advised to return the light to our warehouse or the retailer you purchased it from. The dealer will be able to examine the light and test its components. If they are not able to repair the light, they will return it to us for examination and repair/replacement. Do not attempt to repair any product on your own, as serious injury or death may result. If the retailer is not able to help you and the light is still under manufacturer's warranty, you may contact us for technical support.

If we issue the return process. Please make sure to return the light with all original packaging, your receipt of purchase to the address we give you in the email. Please pack and ship the light in its original packaging. If it is damaged in shipment we cannot be responsible and the warranty may be voided. Once we receive your package, it will be repaired or replaced and shipped back to you.

Thank you!