



SONOFARM

MASTER CONTROLLER USER MANUAL



CONTENTS

1. Important Notes
2. Cautions
3. Package Contents
4. Port Function Description
5. Function Description
6. Product Dimension
7. Warranty Service

1. IMPORTANT NOTES

- Please read this manual thoroughly before attempting to install or operate the product.
- After successful installation and configuration of the system, be sure to keep this manual in a safe location for future reference. Safety is a key component to a long-lasting and trouble-free installation.
- Use all of our products only as instructed. Failure to observe the following safety warnings may result in serious injury or death, and by law, will waive of any and all liability for the manufacturer and resellers.

2. CAUTIONS

- ① Keep the controller in a cool and dry environment, away from dust, high temperature, and humidity.
- ② Ensure that all RJ and power cords are kept safely away from high temperatures, humidity, mechanical movement, or anything that may damage the wires.
- ③ Do not use abrasives, acids, or solvents to clean the controller. Instead, use a soft, dry fabric to clean it.
- ④ Do not try to disassemble or repair the controller; it may cause the controller to malfunction.
- ⑤ Please use a matching data cable; other data cables may cause malfunctions.

3. PACKAGE CONTENTS



4. PORT FUNCTION DESCRIPTION

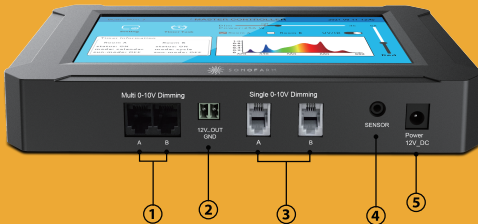

- ① EXT (RJ11-6P6C) 0-10V ports, suitable for MB4 stations when connecting with 6P6C cables.
- ② 12V Output, power supply for other external devices with 12V input.
- ③ EXT (RJ9-4P4C) 0-10V ports, suitable for most LED dimming lights when connecting with 4P4C cables.
- ④ Three-in-one sensor port is for temperature, humidity, and carbon dioxide detection.
- ⑤ 12V DC Input.

5. FUNCTION DESCRIPTION

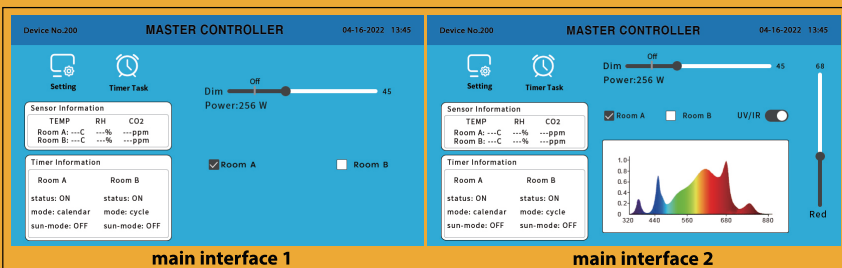

There are two main interfaces for different fixture models.

The main interface 1 is defaultly for wired connection, and for fixture model MB4-S, MB2-I with wireless connection. "DIM" refers to dimming. This is the power (dimming) slider.

The main interface 2 is for MB4 station while wireless connection or wired connection (choose the right fixture modes in light setting).

The "DIM" slider controls white light, red light, and UV/IR.

The "RED" slider controls the power (dimming) of red light (50%-100%) independently based on the DIM.

UV/IR is an independent switch, which is to follow or un-follow the main light fixture.

After successfully connecting the controller and lights, select one of the two rooms and use the slider to adjust the power (dimming) of the lights in the selected room.

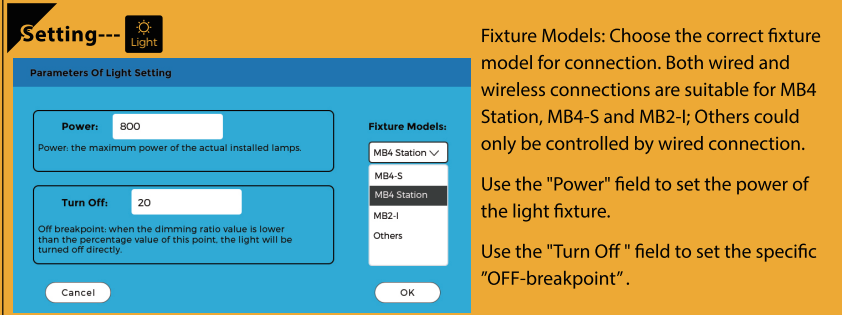
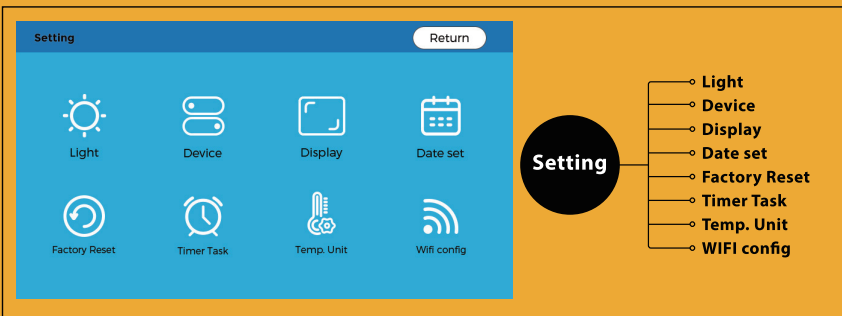

Fixture Models: Choose the correct fixture model for connection. Both wired and wireless connections are suitable for MB4 Station, MB4-S and MB2-I; Others could only be controlled by wired connection.

Use the "Power" field to set the power of the light fixture.

Use the "Turn Off" field to set the specific "OFF-breakpoint".

Setting---



There are three types of networking scenarios.

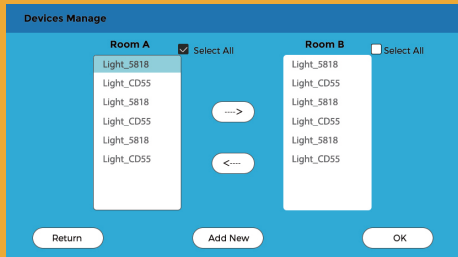

Scenario 1: Connecting light fixtures to the controller for the first time.

- 1 Power ON all the related light fixtures and controllers.
- 2 Turn the dimmer knob of light fixtures to "EXT" level. The fixture will automatically connect with the controller. (Note: All light fixtures are added to Room A by default.)

Scenario 2: Transfer some light fixtures to another room.

- 1 Power OFF all the light fixtures in the room, and restart the controller.
- 2 Power connect with the selected light fixtures, click "Setting" → "Device", you may find the selected lights are in Room A, check "Select All", → Room B, → "OK".
- 3 Power connect with other light fixtures, you can find the selected lights are transferred to Room B, and the rest are remain in Room A. The transfer is completed.



Scenario 3: Light fixtures are connected to another controller (the same model).

- 1 Power ON all the related light fixtures and controllers, keep other lights power OFF. Turn the dimmer knob of light fixtures clockwise five times to dimming level 30%-80%.
- 2 The WIFI symbol will start flashing, which means the light fixtures are waiting to be connected. Click "Setting" → "Device" → "Add New" to the selected room.
- 3 Turn the dimmer knob to "EXT" level. Set-up is done.

Setting---



Display Setting:

Access to set the brightness level of the backlight and adjust the backlight time.

NOTE:

Backlight Brightness refers to the brightness level of the backlight.

Selective range is from 10%-100%.

Backlight Time refers to how long the backlight stays on. Selective range is from 30-600 seconds.

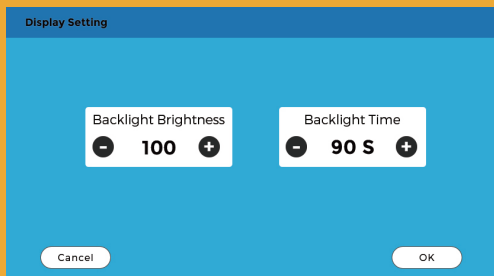

Setting---



Date Setting access to set the time and date of controller.

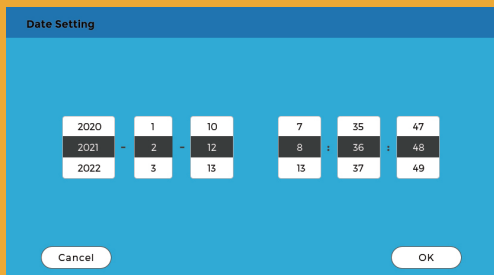

Factory Reset Settings:
All functions will be reset after clicking "OK."

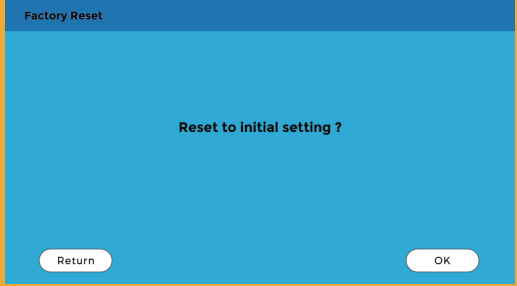

Timer Setting:
There are three timer modes available, plus sunrise and sunset settings.

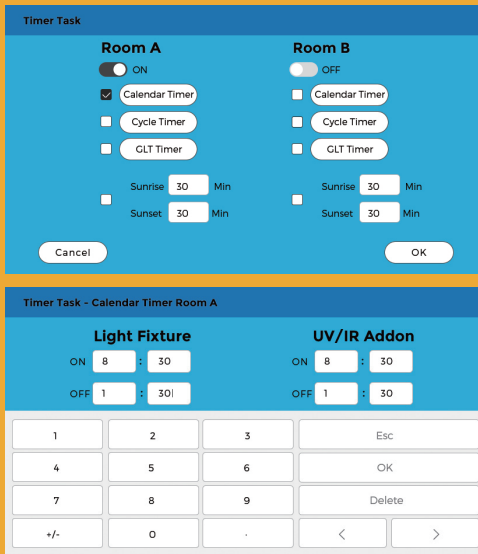

The interface of the timer setting will vary among different product models. There is a separate timer control for products designed with UV/IR spectrum. As shown in the screenshot, the left interface is the one without UV/IR, and the right with UV/IR.

1. Calendar Timer

Calendar Timer:

Access to set the start and end date, and the time for the lights to switch on and off every day.

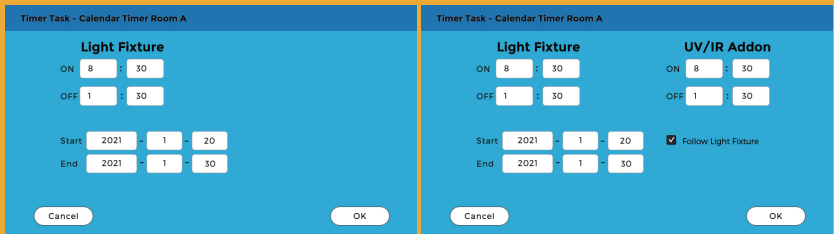

2. Cycle Timer

Cycle Timer:

Access to set the timer cycles (unit: times) and the time for the lights to switch on and off every day.

Timer Task - Cycle Timer Room A

Light Fixture

ON 8 : 30

OFF 1 : 30

Set Cycle 60

Old Cycle: 60

Cancel OK

Timer Task - Cycle Timer Room A

Light Fixture

ON 8 : 30

OFF 1 : 30

Set Cycle 60

Old Cycle: 60

UV/IR Addon

ON 8 : 30

OFF 1 : 30

Follow Light Fixture

Cancel OK

3. GLT Timer

Timer Task - GLT Timer Room A

Light Fixture

Start 8 : 30

Set Cycle 60

Old Cycle: 60

During vegetative state, Gas Lantern Technique is a popular practice in plants growing. The GLT mode goes as 12 Hours on, 5.5 Hours off, 1 hour on, 5.5 hours off, and then repeat next cycle. Compared with traditional 18 hours light on, and 6 hours darkness routine, plants using GLT mode tend to have bigger and shorter vegetative periods. And of course, it saves more energy and cool the facility.

Cancel OK

Timer Task - GLT Timer Room A

Light Fixture

Start 8 : 30

Set Cycle 60

Old Cycle: 60

UV/IR Addon

ON 8 : 30

OFF 1 : 30

Follow Light Fixture

During vegetative state, Gas Lantern Technique is a popular practice in plants growing. The GLT mode goes as 12 Hours on, 5.5 Hours off, 1 hour on, 5.5 hours off, and then repeat next cycle. Compared with traditional 18 hours light on, and 6 hours darkness routine, plants using GLT mode tend to have bigger and shorter vegetative periods. And of course, it saves more energy and cool the facility.

Cancel OK

The GLT Timer is a specific mode that works on a 24-hour cycle.

The light will be ON for 12 hours first, then OFF for 5.5 hours, then ON again for one hour, and finally OFF for 5.5 hours. It access to set the start time and the number of cycles (unit: times).

4. Sunrise Sunset

Sunrise and Sunset Mode:

A mode that simulates sunrise and sunset by adjusting the fixture power every minute to gradually lighten or darken the room within the set time. The rang of minute setting is from 5 to 30.

Timer Task

Room A

ON

Calendar Timer

Cycle Timer

GLT Timer

Sunrise 30 Min

Sunset 30 Min

Cancel OK

Room B

OFF

Calendar Timer

Cycle Timer

GLT Timer

Sunrise 30 Min

Sunset 30 Min

Setting---

“Auto DIM To 70% By” is the over-temperature operation.

After you enter this temperature setting, the light power will drop to 70% of the initial power when the ambient temperature is higher than the set temperature. One hour later, if the ambient temperature is still higher than the set temperature, it will drop to 70% again. The light power will return to the initial lighting status when the ambient temperature is lower than the set temperature.

“Auto Turn Off By” is to set the over-temperature protection.

After you enter this temperature setting, the light will automatically turn off when the ambient temperature is higher than the setting temperature. It will automatically return to the initial lighting status when the ambient temperature is lower than the set temperature.

“Unit” refers to the temperature unit setting.

There are two units available: Fahrenheit or Celsius.

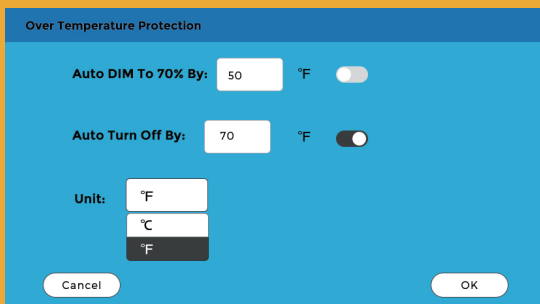

Setting---

WiFi Setting: Users can connect to a WiFi hotspot to update the system. It's just for system updating, not for light connection. It's automatic networking between light and controller, no need to connect with a WiFi hotspot.

Enter your SSID account and password, click "OK." Next, click "Update" to download the latest system after the WiFi hotspot is successfully connected.

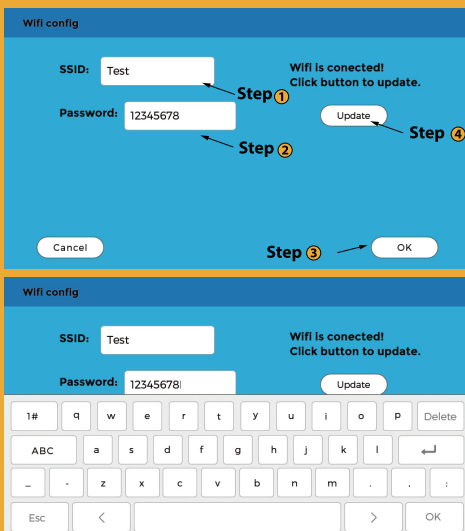

6. PRODUCT DIMENSIONS

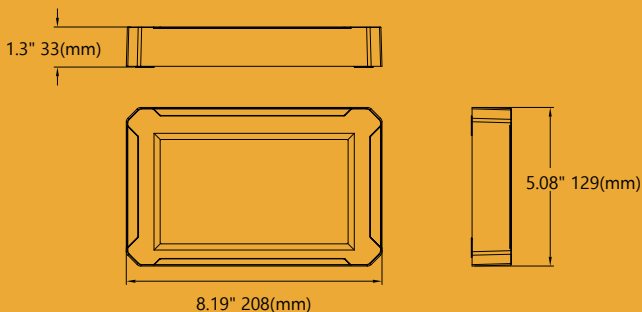

7. WARRANTY SERVICE

If the product does not work after you have read the troubleshooting guide and practiced the troubleshooting options, please return the product to our warehouse or the retailer where you purchased it. The dealer will be able to examine the product and test its components. If they are not able to repair the product, they will return it to us for examination and repair/replacement. Do not attempt to repair any product on your own, as serious injury or death may result. If the retailer cannot help you and the product is still under the manufacturer's warranty, you may contact us for technical support.

If we initiate the return process, please return the product with all original packaging and your receipt of purchase to the address we provide you in the email. Please pack and ship the product in its original packaging. If it is damaged in shipment, we cannot be responsible and the warranty may be voided. Once we receive your package, we will repair or replace it and ship it back to you.

Thank you!

SonoFarm generates lighting technology and accessories and establishes controlled environments for the development of both home grown produce as well as commercial crops.

We implement the most current research and rigorously test our precisely engineered products.

At SonoFarm, we strive to propagate continual life-more sustainable agriculture is possible with easily accessible light sources.